



A Garmin Brand



MediaMaster® 55

MARINE SOURCE UNIT

OWNER'S MANUAL



FCC COMPLIANCE STATEMENT

This device complies with Part 15 of the FCC Rules. Operation is subject to the following two conditions:
 (1) this device may not cause harmful interference, and
 (2) this device must not accept any interference received, including interference that may cause undesired operation. These limits are designed to provide reasonable protection against harmful interference in a residential installation.

This equipment generates, uses and can radiate radio frequency energy and, if not installed in accordance with the instructions, may cause harmful interference to radio communications. However, there is no guarantee that interference will not occur in a particular installation. If this equipment does cause harmful interference to radio or television reception, the user is encouraged to try to correct the interference by one or more of the following measures:

- Reorient or relocate the receiving antenna.
- Increase separation between the equipment and the receiver.
- Connect the equipment to an outlet on a circuit different from that to which the receiver is connected.
- Consult the dealer or an experienced radio/TV technician for help.

Any changes or modifications not expressly approved by the party responsible for compliance could void the user's authority to operate this equipment.

FCC RADIATION EXPOSURE STATEMENT

This device complies with FCC radiation exposure limits set forth for an uncontrolled environment. This equipment should be installed and operated with a minimum distance of 20 cm between the radiator and any part of your body.

CANADA STATEMENT

This device contains licence-exempt transmitter(s)/receiver(s) that comply with Innovation, Science and Economic Development Canada's licence-exempt RSS(s). Operation is subject to the following two conditions:

- (1) This device may not cause interference.
- (2) This device must accept any interference, including interference that may cause undesired operation of the device.

The device meets the exemption from the routine evaluation limits in section 2.5 of RSS 102 and compliance with RSS-102 RF exposure, users can obtain Canadian information on RF exposure and compliance. This equipment meets the exemption from the routine evaluation limits in section 2.5 of RSS-102. It should be installed and operated with a minimum distance of 20cm between the radiator and any part of your body.

SAFETY CONSIDERATIONS

- Only use this product in vehicles with 12 volt, negative-ground electrical systems. This product is not certified or approved for use in aircraft.
- Mount this product securely to prevent damage or injury in severe conditions.
- Do not replace the power wire fuse with one of a different value. Never bypass the fuse.
- Listen to your audio system at levels appropriate for operating conditions and hearing safety.

INSTALLATION CONSIDERATIONS

- Installation requires appropriate tools and safety equipment. Professional installation is recommended.
- This product is water-resistant. Do not submerge or subject to high-pressure water spray.
- Before installation, turn off the audio system and disconnect the battery system from the audio system.
- Install in a dry, well-ventilated location that does not interfere with your factory-installed systems. If a dry environment is not available, a location that is not exposed to heavy splashing may be used.
- Before cutting or drilling, check for potential obstacles behind mounting surfaces.
- Carefully route all system wiring away moving parts and sharp edges; secure with cable ties or wire clamps and use grommets and loom where appropriate to protect from sharp edges.

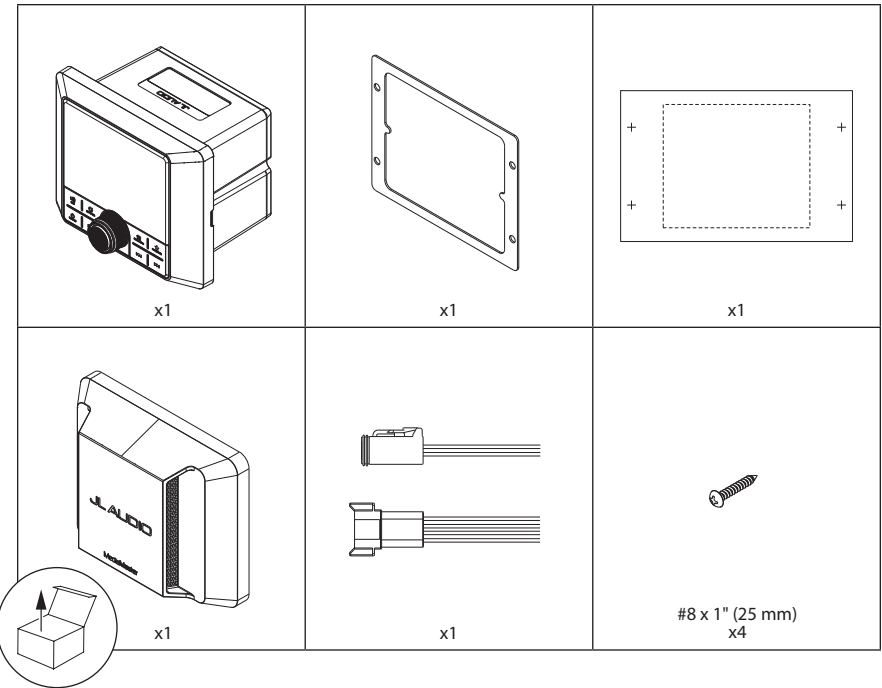

GENERAL MOUNTING

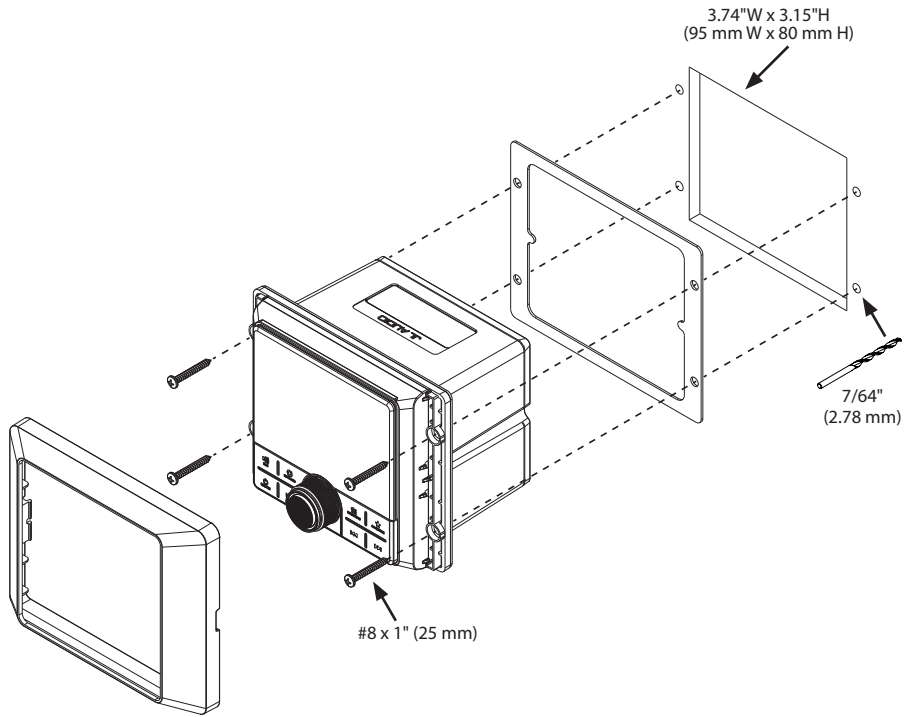



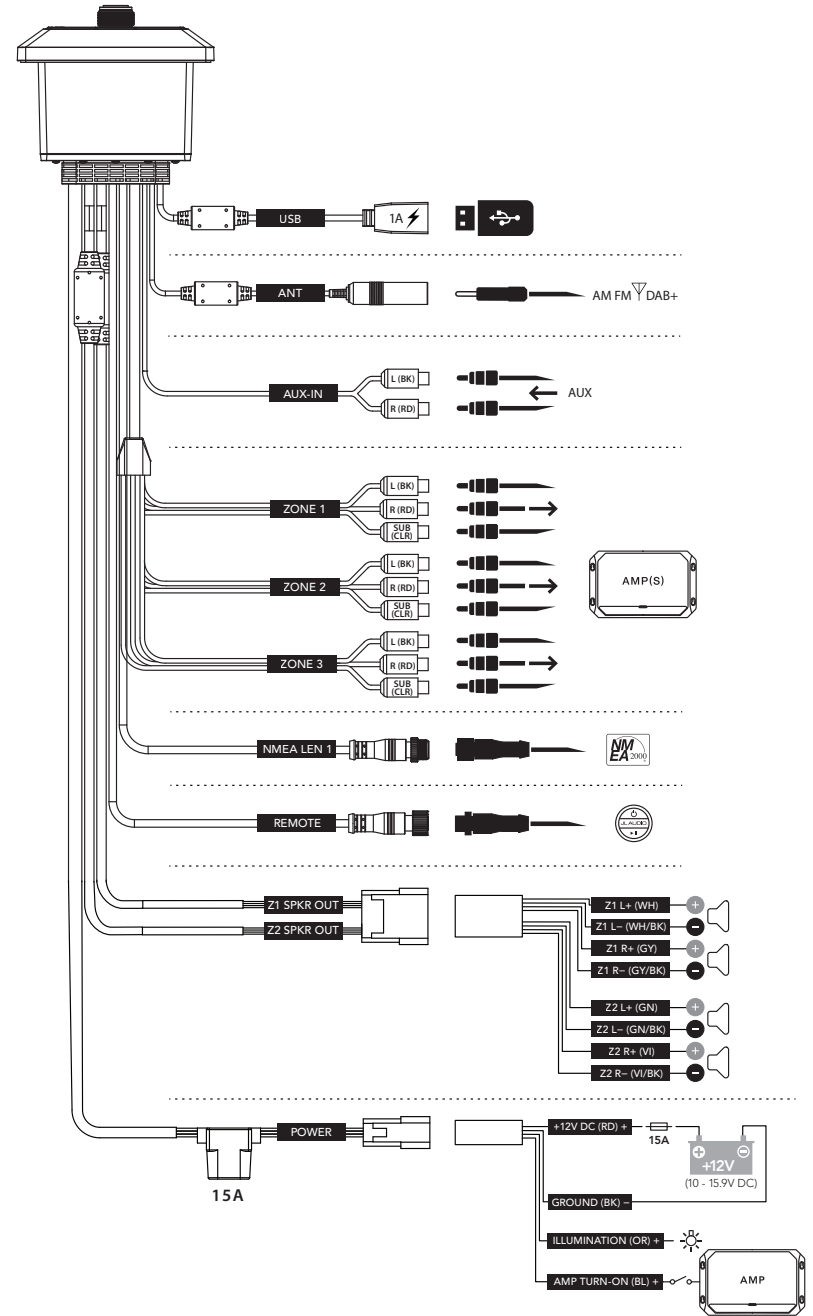





GENERAL CONNECTIONS







CONTROL PANEL



GENERAL CONTROL FUNCTIONS



Control	Function	
 SOURCE	Source/ Power	<ul style="list-style-type: none"> • Short press to turn ON; Long press to turn OFF • While on, short press to display the SOURCE: Select menu
	Volume/ Select	<ul style="list-style-type: none"> • Rotate to adjust Audio Zone Levels (volume) • Rotate to navigate • Press to make selections
 SUB	SUB	<ul style="list-style-type: none"> • Short press to access Subwoofer Trim Level settings
 SETTINGS	Settings	<ul style="list-style-type: none"> • Short press to access the Audio Zone: Tone & Balance settings • Long press to access the System Settings: Main Menu
 BACK/MENU	Back/ Menu	<ul style="list-style-type: none"> • Short press to go back one step or access source specific menus
 FAVORITES	Favorites	<ul style="list-style-type: none"> • Short press to access stored presets • Long press to store a frequency as a preset (up to 18)
	Mute/ Pause	<ul style="list-style-type: none"> • Short press to mute/unmute audio (AM/FM/DAB+/AUX) or pause/resume the current selection (USB/Bluetooth®) • When the Audio Zone Levels screen is displayed, short press to mute all audio (AM/FM/DAB+/AUX/USB/Bluetooth®)
	Forward	<p>Short press to:</p> <ul style="list-style-type: none"> • Manually adjust tuner forwards (AM/FM/DAB+) • Select the next track (USB/Bluetooth®) <p>Long press to:</p> <ul style="list-style-type: none"> • Seek to the next channel (FM); Skip forward ten frequency steps (AM) • Fast-forward (USB)
	Backward	<p>Short press to:</p> <ul style="list-style-type: none"> • Manually adjust tuner backwards (AM/FM/DAB+) • Restart track/select the previous track (USB/Bluetooth®) <p>Long press to:</p> <ul style="list-style-type: none"> • Seek to the previous channel (FM); Skip backwards ten frequency steps (AM) • Fast-rewind (USB)

SYSTEM MENU SETTINGS	
	• Long press to access the System Settings: Main Menu
	• Rotate to navigate • Press to make selections
Setting	Function
Name this Device	Create a custom name to display on devices connected with Bluetooth® wireless technology or for NMEA 2000® networks
Audio Zone Setup	Configures each set of audio zone outputs
AUX Input Sensitivity	Configures AUX input sensitivity: 2V or 1V RMS (default)
Diagnostic	Displays serial number, hardware and software version info
Display	Configures display and brightness settings
Battery Monitor	Notifies when +12VDC supply voltage drops below 10 volts or above 16 volts If triggered, the unit will enter Safe Mode with a message to turn the unit off until normal operating voltage is restored
Scrolling Text	Enables continuous scrolling of available RDS/track text info
Tuner Region	Configures AM/FM tuner range/scale for a specific region
Power-up Settings	Configures display and volume settings upon activation
Mobile Application	Access pairing options for mobile device application control
Remote Control	Access pairing options for controllers equipped with Bluetooth® wireless technology
Language	Configures displayed navigation controls and user interface language

AUDIO ZONE SETUP MENU SETTINGS				
	• Long press to access the System Settings: Main Menu			
	• Rotate to navigate • Press to make selections			
Zone	Function	Setting 1	Setting 2	
Z1: Zone 1 Z2: Zone 2 Z3: Zone 3	Level Control Mode	Relative: Links the volume levels of Zones 2 - 3 with the level of Zone 1. (Linked zones will proportionally follow Zone 1's volume.) Each zone's offset level is independently adjustable, allowing you to create a customized level controller, specific to a vessel's layout.		
		Absolute: Creates an independent level control for selected zones, each with its own separate volume level slider.		
		Fixed	4V RMS Max (default) 2V RMS Max 1V RMS Max	
		Off		
	Rename Zone	Bow, Bridge, Cabin, Cockpit, Galley, Helm, Stateroom 1, Stateroom 2, Tower, Transom		
		Custom Name		Alphanumeric Input
		Factory Default		
	Max Volume Limit	Max Vol Limit		
	HPF	High Pass Filter		Off (default) 80 Hz 100 Hz 120 Hz
	Sub 1 Sub 2 Sub 3	LPF (Low Pass Filter)		Off (default) 60 Hz 80 Hz 100 Hz
		Sub Off		

AUDIO STREAMING WITH BLUETOOTH® WIRELESS TECHNOLOGY

You may listen to audio wirelessly from up to 35 feet away (11 m) using compatible devices equipped with Bluetooth® wireless technology. Up to eight devices can be paired, but only one streaming device can connect at a time.

SETTINGS FOR DEVICES WITH BLUETOOTH® WIRELESS TECHNOLOGY	
 BACK/MENU	• With Bluetooth® selected as a source, short press to display the Bluetooth® : Main Menu
	• Rotate to navigate • Press to make selections
Setting	Function
Now Playing	Return to the Now Playing Screen
Pair New Device	Initiates Pairing Mode (connected devices will be disconnected)
Connect Paired Device	Display all paired devices for connection
Set Primary Device	Assign priority to a paired device for automatic connection
Delete a Paired Device	Select from paired devices for removal
Delete All Paired Devices	Removes all paired devices from memory

! IMPORTANT



- Hereby, Garmin declares that the radio equipment type MM55 is in compliance with Directive 2014/53/EU. The full text of the EU declaration of conformity is available at the following internet address: www.garmin.com/compliance
- MM55 Wireless Specification:
Bluetooth transmitter frequency range: 2400 MHz - 2483.5 MHz
Bluetooth transmitter power: <14 dBm (EIRP)

! IMPORTANT

- Hereby, Garmin declares that this MM55 is in compliance with the essential requirements and other relevant provisions of Radio Equipment Regulations 2017. The full text of the UK declaration of conformity is available at the following internet address: www.garmin.com/compliance

USB CONNECTIONS

Use the USB port to connect with USB storage class devices (thumb drive, digital audio player, etc.). Includes 1 A charging output.

USB MENU SETTINGS	
 BACK/MENU	• With USB selected as a source, short press to display USB: Main Menu
	• Rotate to navigate • Press to make selections
Setting	Function
Now Playing	Return to the Now Playing Screen
Shuffle	Activate Shuffle: On or Off (default)
Repeat	Activate Repeat: All, Song or Off (default)
Play All	Plays all content within all folders

! IMPORTANT

- Properly secure the connected device before driving to prevent damage from dropping or sudden acceleration/braking.
- Control, functionality and display may vary depending on the model and version of the connected device.
- When connected via USB port, make sure to unpair or disable the device's wireless connection to avoid possible playback conflicts.
- If you experience abnormal performance during operation, disconnect the device and check its condition. Restart your device if performance does not improve.

OPTIONAL CONTROLLER AND INTERFACE ACCESSORIES

The following connections are included for adding accessories (sold separately). Refer to the supplied owner's manual of each accessory for specific user and installation instructions.

Connection for NMEA 2000® Networks

Micro-C plug permits direct connection to a vessel network using accessory cables and connectors (sold separately).

Note: Functionality requires compatible entertainment protocols (PGN) for NMEA 2000® networks and may require a software upgrade of your multifunction display (MFD). Refer to your MFD manufacturer for device compatibility info.

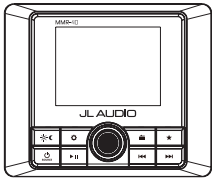

MediaMaster® MMR-40 Network Controller

Full-function, water-resistant (IP66 rated) controller with full-color LCD display



Multifunction Display (MFD) Control
Achieve control functionality using your vessel's multifunction display MFD

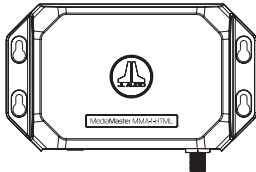

MediaMaster® MMA-1-HTML MFD Data Interface
Digital interface generates themed navigation and controls onto your vessel's multifunction display (MFD)



MediaMaster® MMR-5N2K Network Volume Controller
Water-resistant (IPX7 rated) controller

Connection using Bluetooth® Wireless Technology

Ultra-efficient Bluetooth® Low Energy technology permits wireless control from up to 35 feet (11 m) away. Pair up to eight remotes to a single source unit.

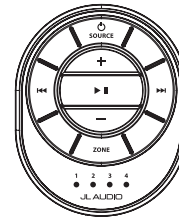

MediaMaster® MMR-25W Wireless Controller
Water-resistant (IP68 rated) controller

Connection for Wired Remotes

Remote plug permits direct connection of wired controllers using accessory cables and splitters. Add up to three remotes to a single source unit, at up to 75 feet (23 m) away.

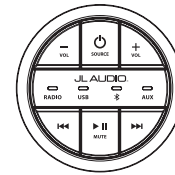

MediaMaster® MMR-20-BE Wired Remote Controller
Water-resistant (IP67 rated) controller



MediaMaster® Remote Controller App
Free, full-function, application controller using your compatible wireless device
Note: App functionality may require update of source unit software. Visit: www.jlaudio.com/support



SPECIFICATIONS

Electrical	
Operating Voltage	14.4V DC (10V – 16V)
Operating Temp Range	-4 F to +149 F (-20 C to +65 C)
Current Draw / Fuse Value	15 A (max) / 100 mA (standby) / 15 A
NMEA 2000® LEN	1 (Micro-C connector)
Display / Resolution	2.8" TFT LCD backlitged / 320 x 240
Preamp Audio Outputs/Inputs	
Output Channels	One stereo pair and mono subwoofer RCA plugs per zone
Output Configuration	Relative, Absolute, Fixed or Off
Maximum Output Voltage	Relative or Absolute: 4V RMS Fixed: Selectable 4V/2V/1V RMS
Output Impedance	250 Ω
Auxiliary Input	One stereo pair of RCA plugs (2V/1V RMS Input Sensitivity)
Amplified Audio Outputs	
Rated RMS Power @ 14.4V	25W x 4 @ 4 Ω
Minimum Impedance	2 Ω per channel
Sound Control Options	
Tone and Balance	Treble, Midrange, Bass and Balance (all zones)
High-Pass Filter	Off, 80 Hz, 100 Hz and 120 Hz (each zone)
Low-Pass Filter	Off, 60 Hz, 80 Hz and 100 Hz (each subwoofer zone)
Tuner	
FM Tuner with RDS	87.5 MHz to 107.9 MHz (0.2 MHz step)
AM Tuner	530 kHz to 1710 kHz (10 kHz step)
DAB+ Tuner	170 MHz to 230 MHz
Favorites	18 presets across all tuners
Bluetooth®	
Profile	A2DP v1.2, AVRCP v1.4
Core Specification	Version 2.1 + EDR
Codec	SBC, Qualcomm® aptX™ audio
Connection Range	Up to 35' (11 m)
USB	
Interface	USB 2.0
Maximum Charging Output	1 A
Supported Audio Formats	MP3, MP4, WAV, AAC, M4A, M4B
Dimensions	
Unit W x H x D	4.65" x 3.74" x 3.66" (118 mm x 95 mm x 93 mm)
Mounting Hole W x H	3.74" x 3.15" (95 mm x 80 mm)



A Garmin Brand



MediaMaster® 55

RÉCEPTEUR MARITIME

MANUEL D'UTILISATION





A Garmin Brand

© 2024 Garmin Ltd. or its subsidiaries

All rights reserved. Garmin reserves the right to change or improve its products and to make changes in the content of this manual without obligation to notify any person or organization of such changes or improvements. For help with your product, go to <https://www.jlaudio.com/support>.

Garmin®, JL Audio and MediaMaster are trademarks of Garmin Ltd. or its subsidiaries, registered in the USA and other countries. The JL Audio logo and the MediaMaster logo are trademarks of Garmin Ltd. or its subsidiaries. These trademarks may not be used without the express permission of Garmin.

The BLUETOOTH® word mark and logos are owned by Bluetooth SIG, Inc. and any use of such marks by Garmin is under license. NMEA 2000®, and the NMEA 2000 logo are registered trademarks of the National Marine Electronics Association. Other trademarks and trade names are those of their respective owners.